

مذكرة الرسم والأشكال التوضيحية

أحياء ثانوية عامة
اعداد
أ/ نبيل أبو شاهين

aboushahin3000@hotmail.com

0102202654

بِسْمِ اللَّهِ الرَّحْمَنِ الرَّحِيمِ (وَاصْبِرْ وَمَا صَبْرُكَ إِلَّا بِاللَّهِ وَلَا تَحْزَنْ عَلَيْهِمْ وَلَا تَكُ فِي ضَيْقٍ مِّمَّا يَمْكُرُونَ) (النحل: 127)

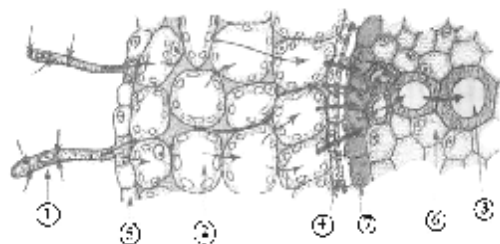
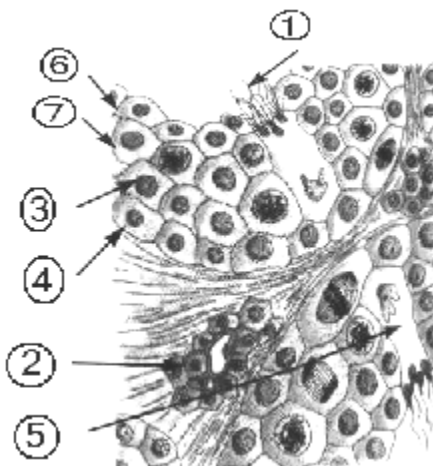
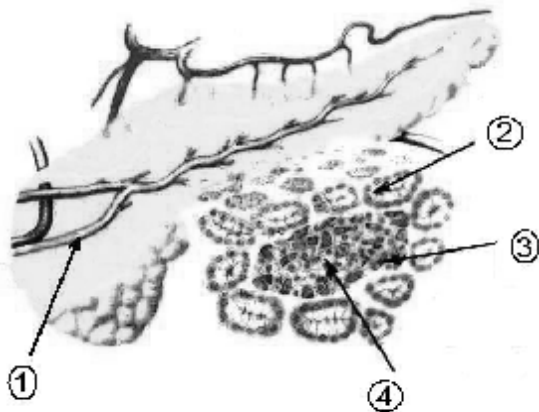
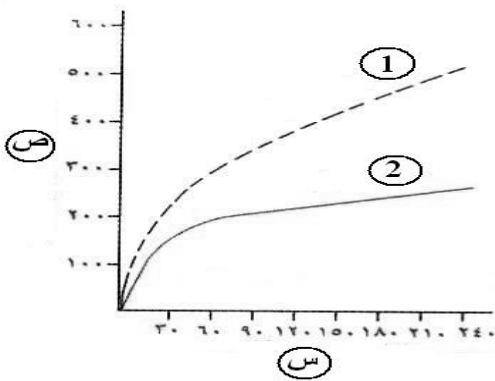
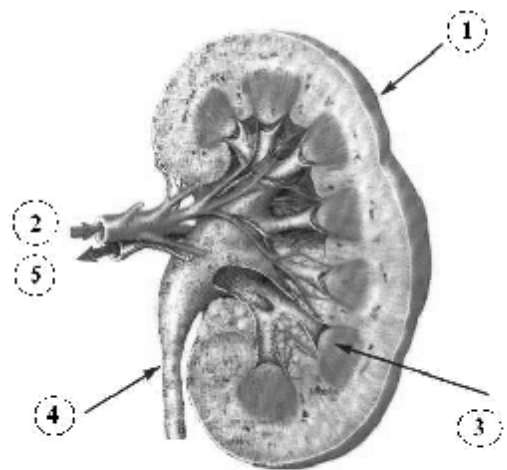
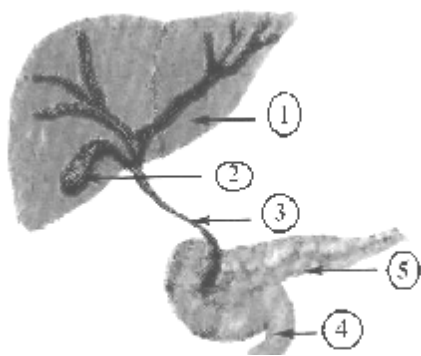
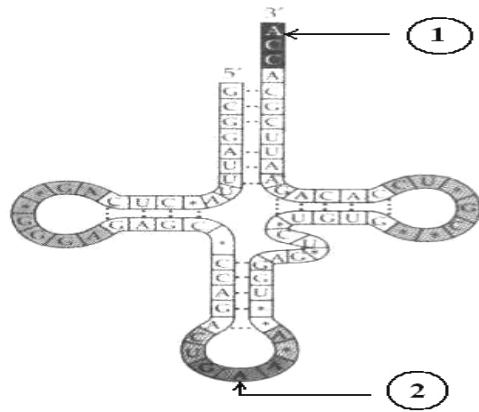
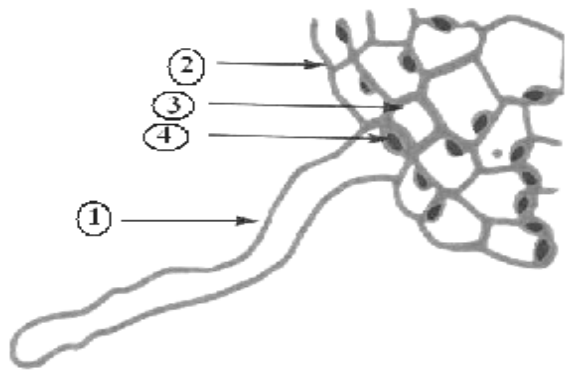

بِسْمِ اللَّهِ الرَّحْمَنِ الرَّحِيمِ (وَاصْبِرْ وَمَا صَبْرُكَ إِلَّا بِاللَّهِ وَلَا تَحْزَنْ عَلَيْهِمْ وَلَا تَكُ فِي ضَيْقٍ مِمَّا يَمْكُرُونَ) (النحل: 127)

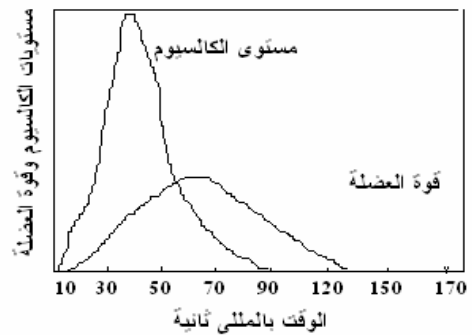
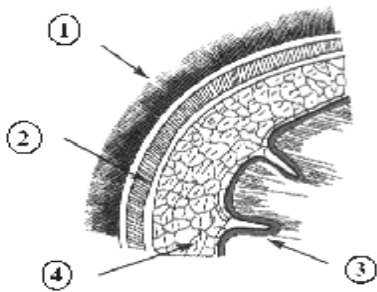
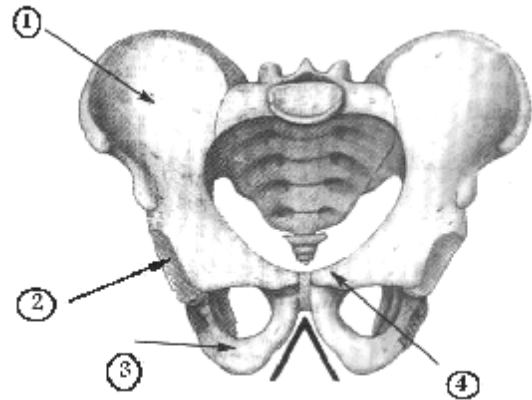
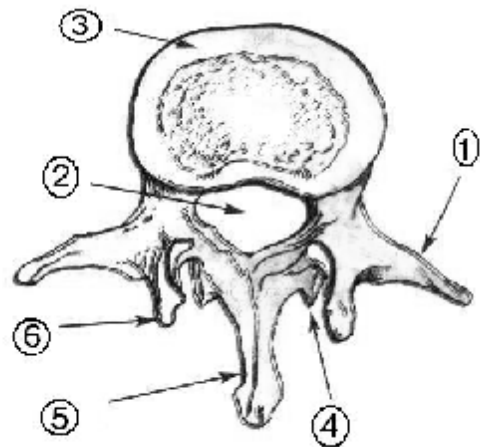
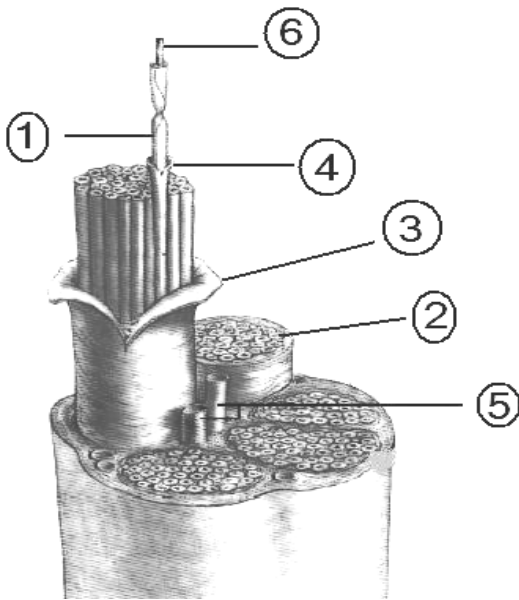
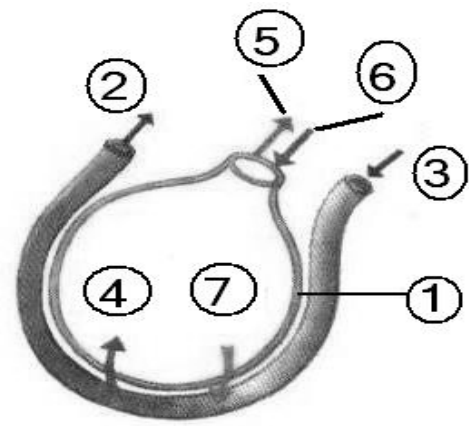
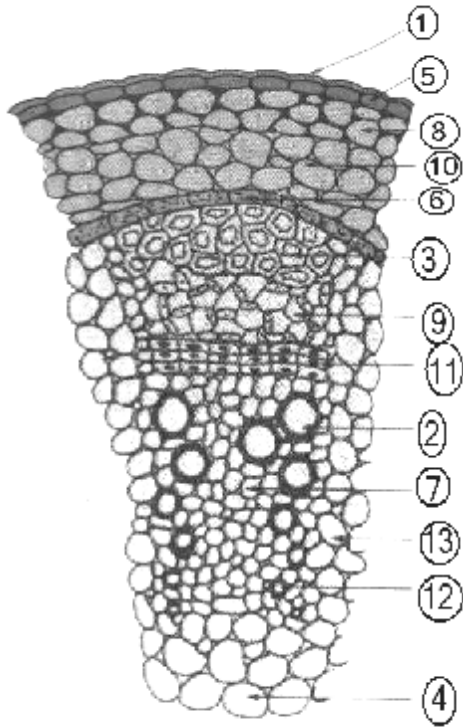

بِسْمِ اللَّهِ الرَّحْمَنِ الرَّحِيمِ (وَاصْبِرْ وَمَا صَبْرُكَ إِلَّا بِاللَّهِ وَلَا تَحْزَنْ عَلَيْهِمْ وَلَا تَكُ فِي ضَيْقٍ مِمَّا يَمْكُرُونَ) (النحل: 127)

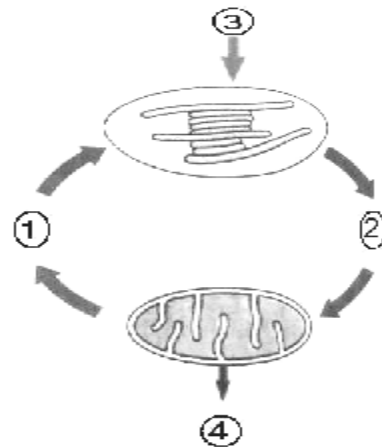
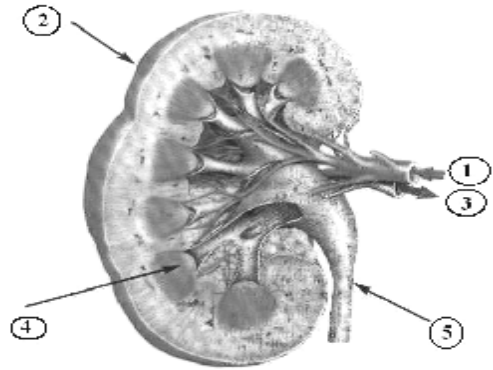
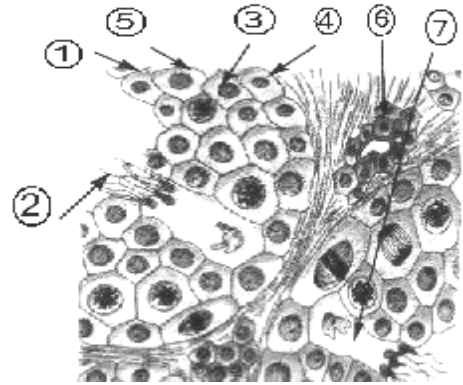
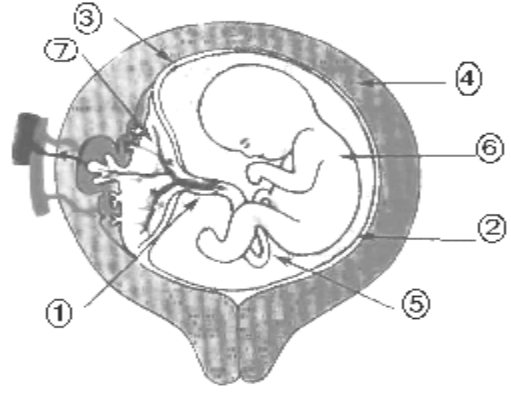
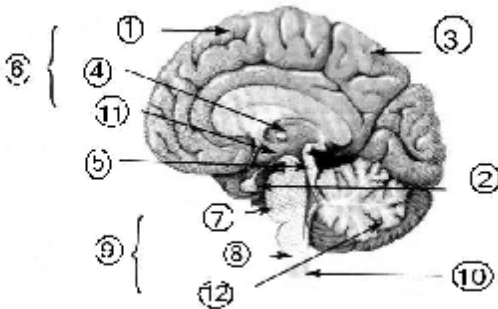
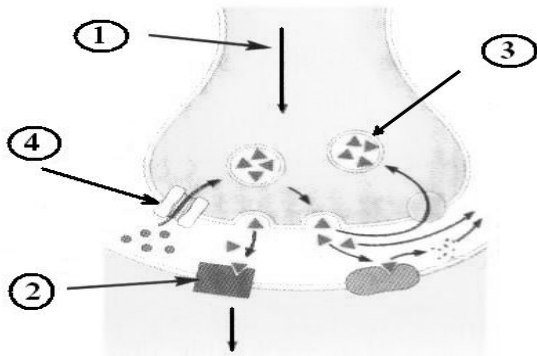
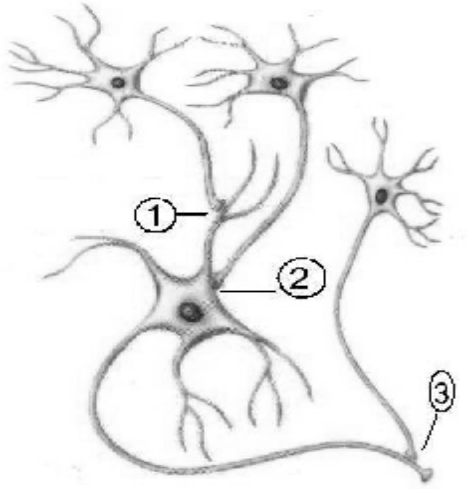
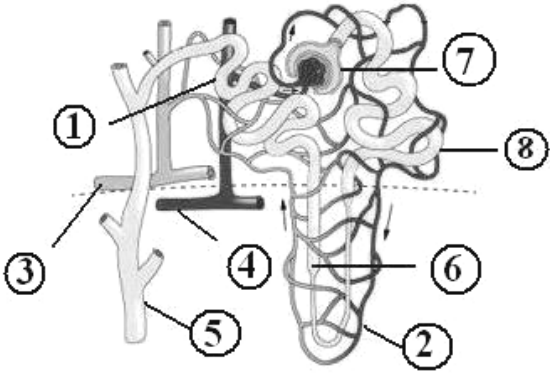

بِسْمِ اللَّهِ الرَّحْمَنِ الرَّحِيمِ (وَاصْبِرْ وَمَا صَبْرُكَ إِلَّا بِاللَّهِ وَلَا تَحْزَنْ عَلَيْهِمْ وَلَا تَكُ فِي ضَيْقٍ مِّمَّا يَمْكُرُونَ) (النحل: 127)

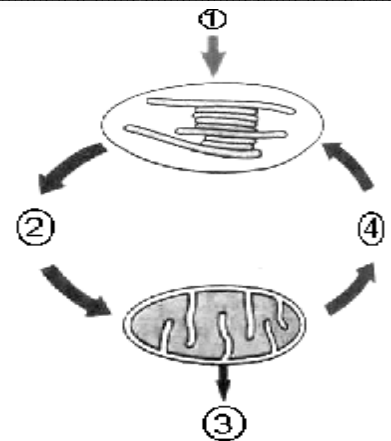
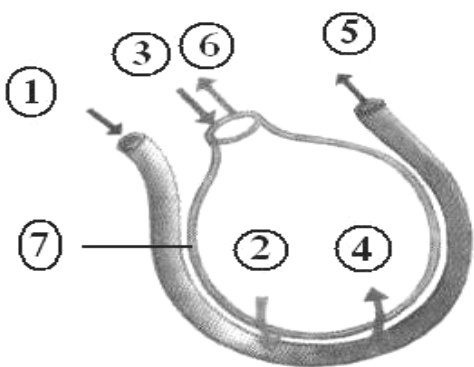
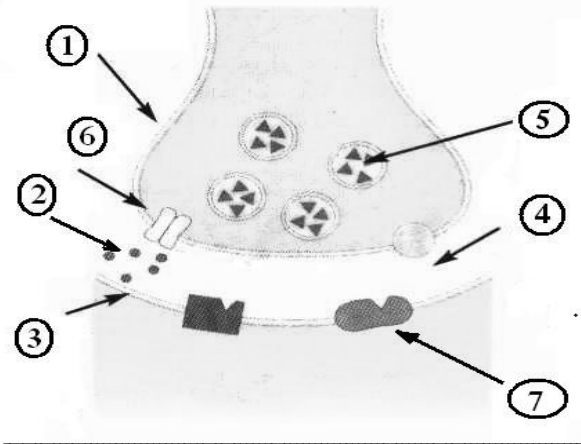
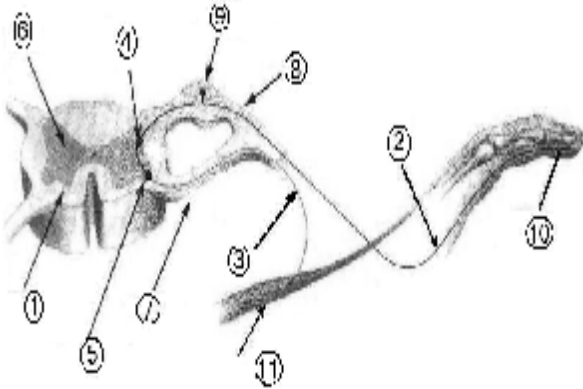
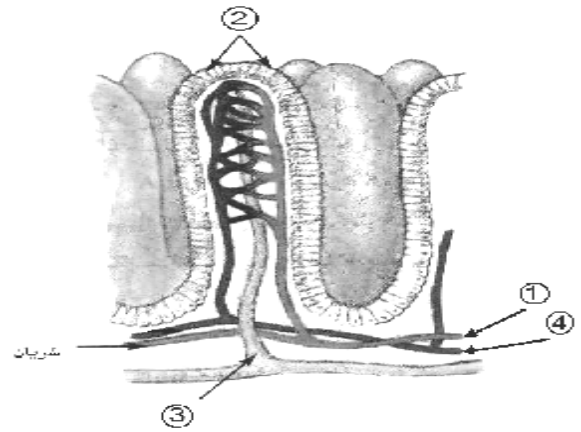
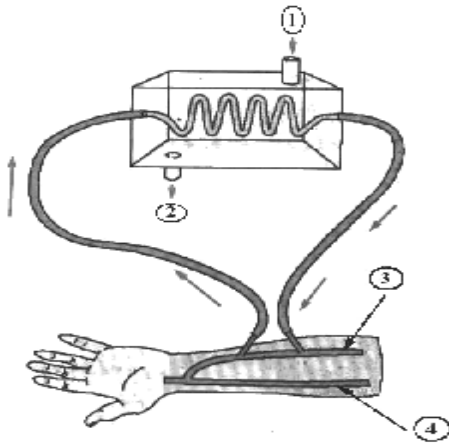
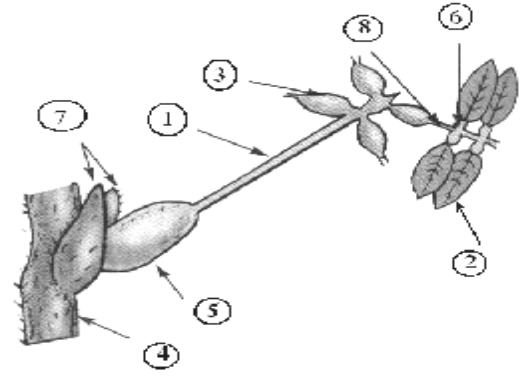
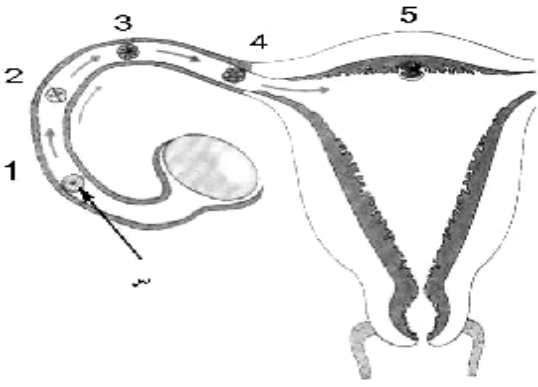

بِسْمِ اللَّهِ الرَّحْمَنِ الرَّحِيمِ (وَاصْبِرْ وَمَا صَبْرُكَ إِلَّا بِاللَّهِ وَلَا تَحْزَنْ عَلَيْهِمْ وَلَا تَكُ فِي ضَيْقٍ مِّمَّا يَمْكُرُونَ) (النحل: 127)

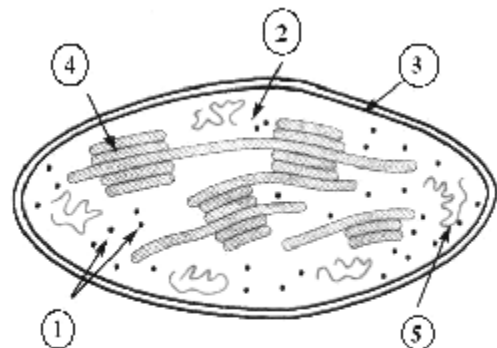
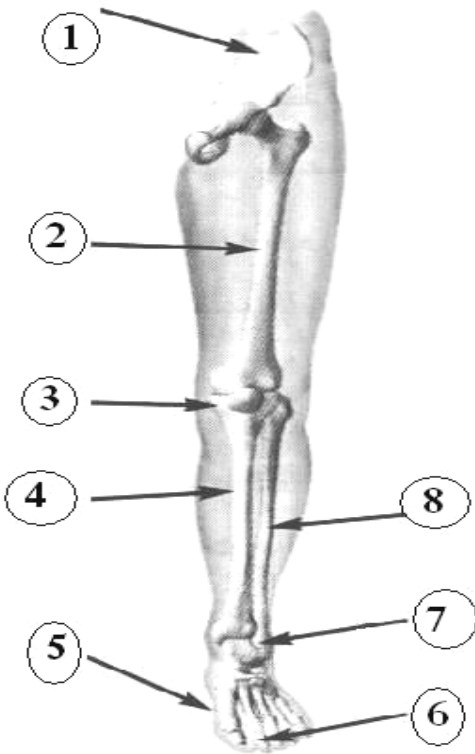
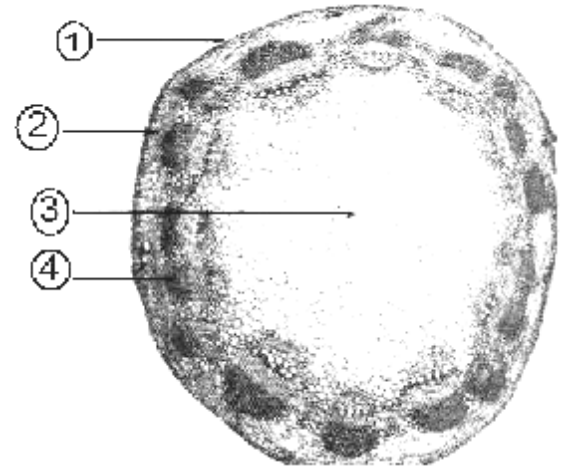
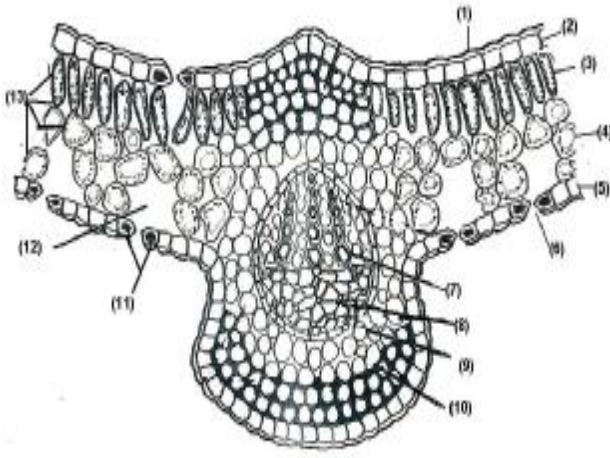
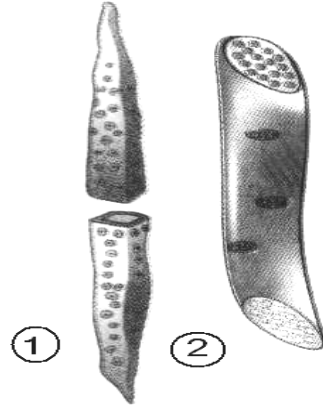
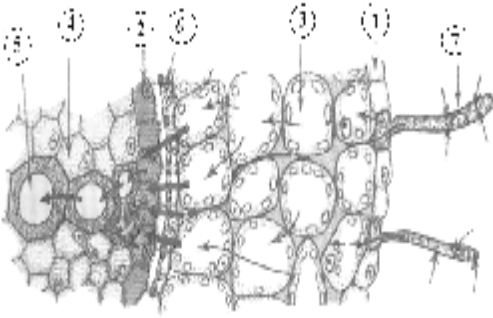

بِسْمِ اللَّهِ الرَّحْمَنِ الرَّحِيمِ (وَاصْبِرْ وَمَا صَبْرُكَ إِلَّا بِاللَّهِ وَلَا تَحْزَنْ عَلَيْهِمْ وَلَا تَكُ فِي ضَيْقٍ مِّمَّا يَمْكُرُونَ) (النحل: 127)

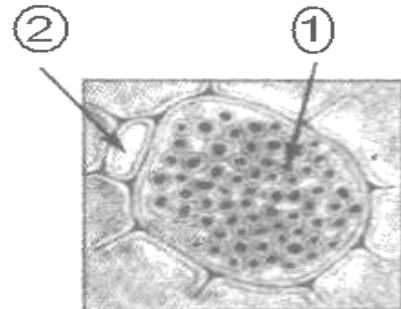
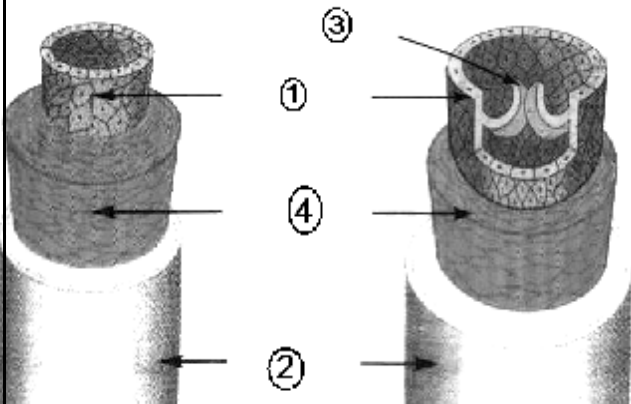
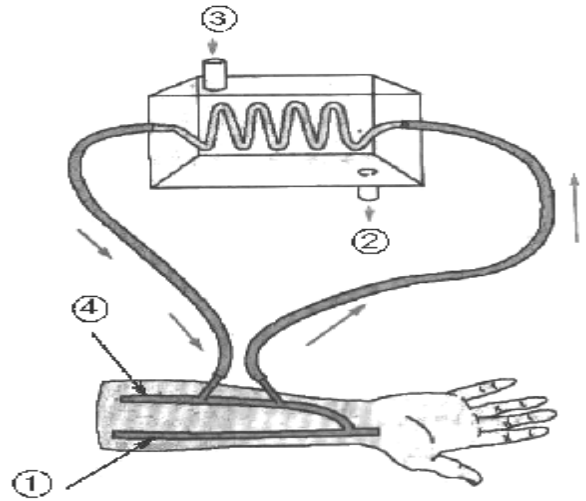
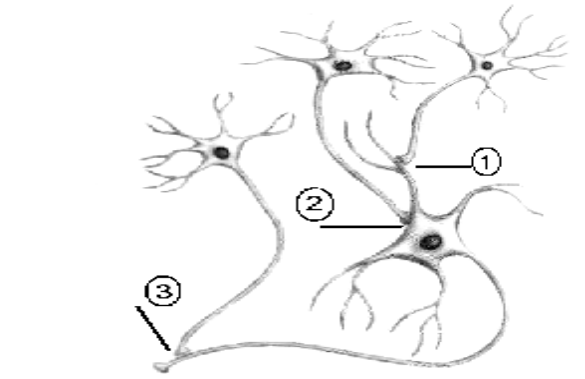
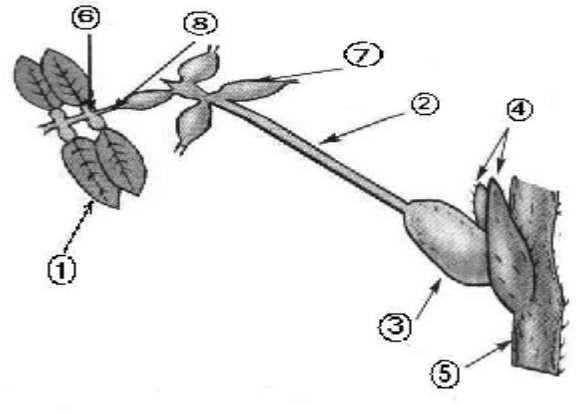
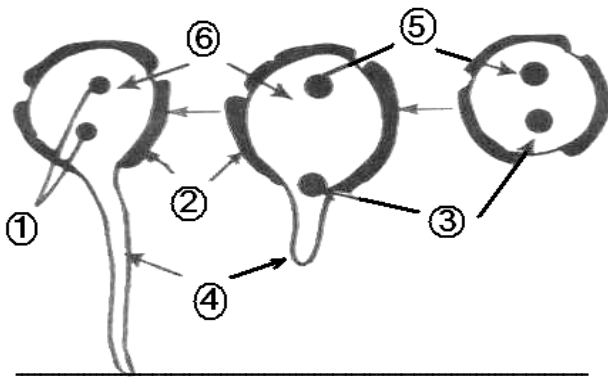
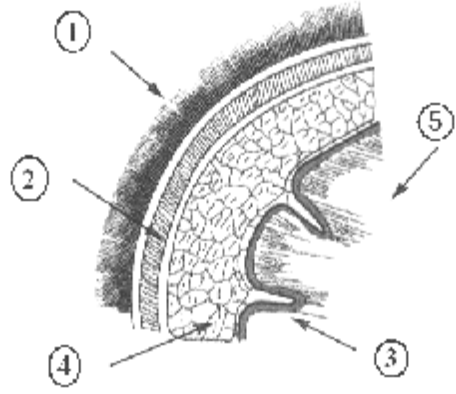
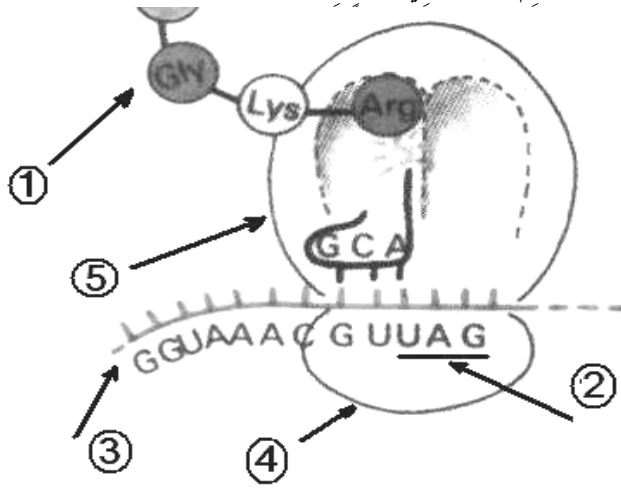

بِسْمِ اللَّهِ الرَّحْمَنِ الرَّحِيمِ (وَاصْبِرْ وَمَا صَبْرُكَ إِلَّا بِاللَّهِ وَلَا تَحْزَنْ عَلَيْهِمْ وَلَا تَكُ فِي ضَيْقٍ مِمَّا يَمْكُرُونَ) (النحل: 127)

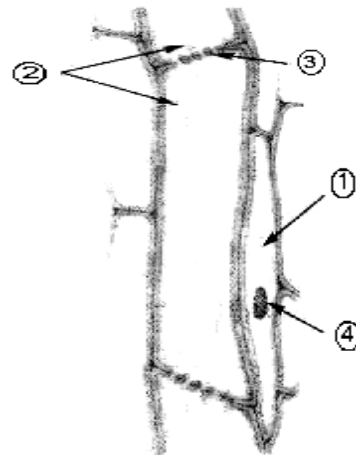
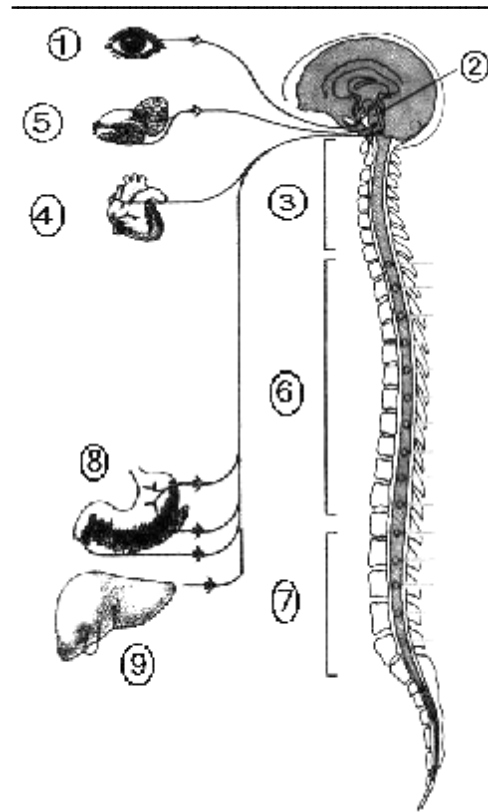
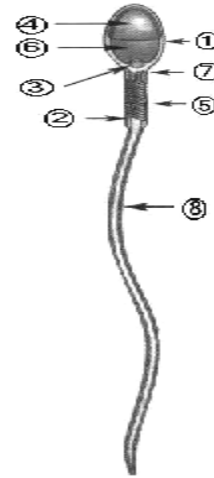
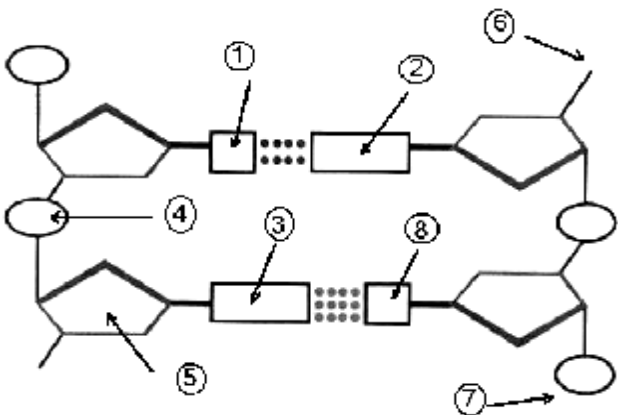
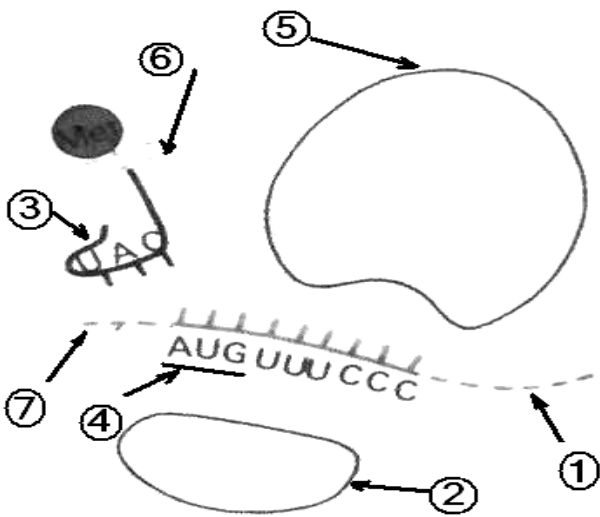
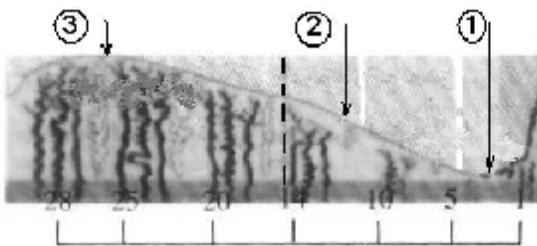
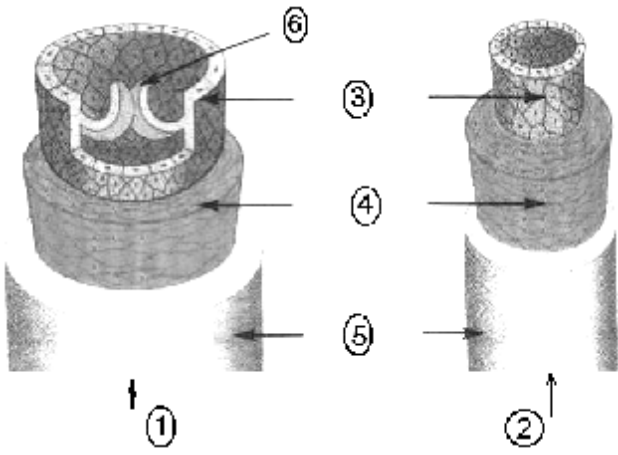

بِسْمِ اللَّهِ الرَّحْمَنِ الرَّحِيمِ (وَاصْبِرْ وَمَا صَبْرُكَ إِلَّا بِاللَّهِ وَلَا تَحْزَنْ عَلَيْهِمْ وَلَا تَكُ فِي ضَيْقٍ مِمَّا يَمْكُرُونَ) (النحل: 127)

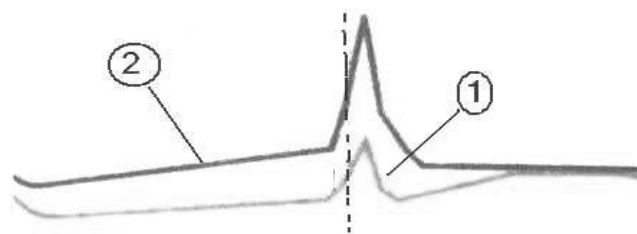
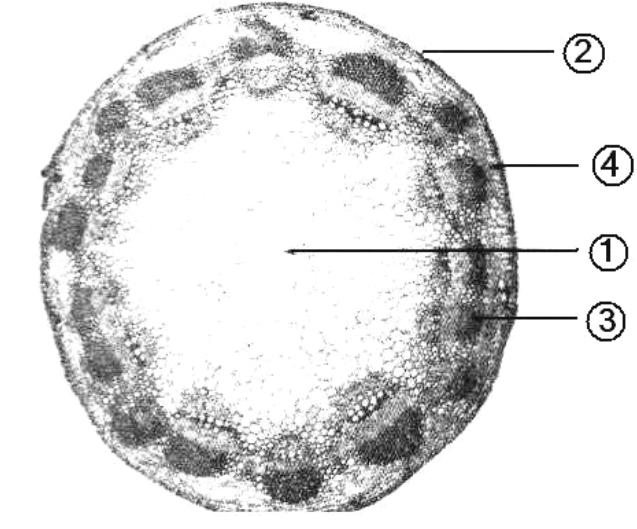
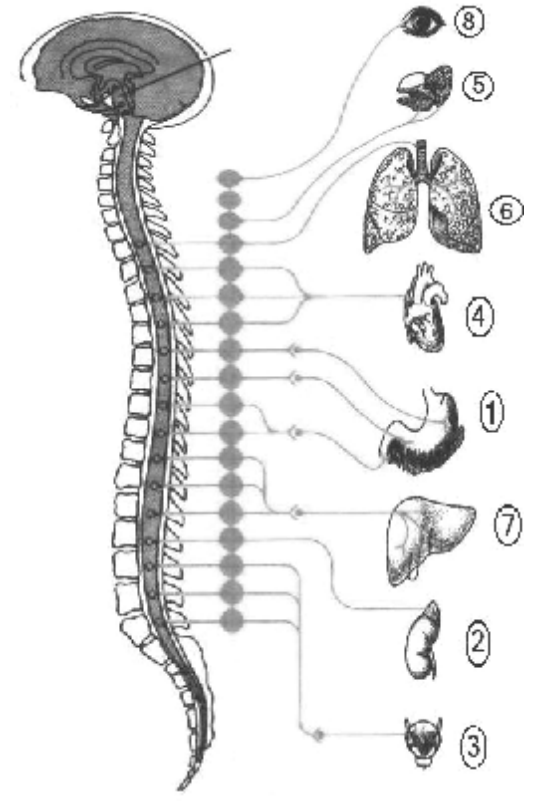
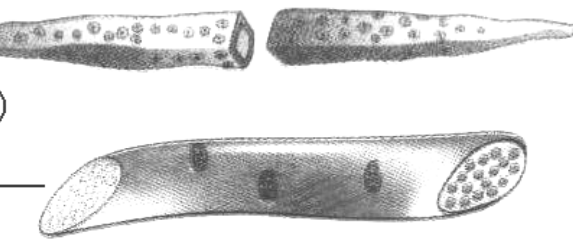
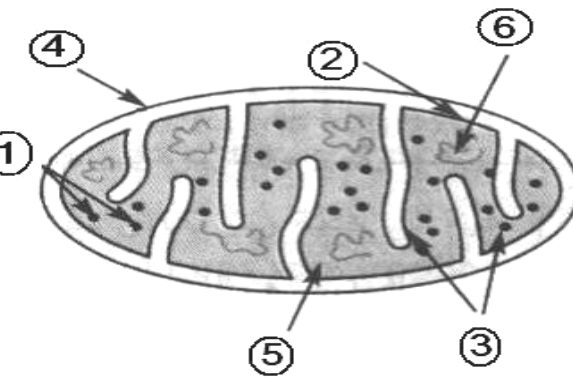
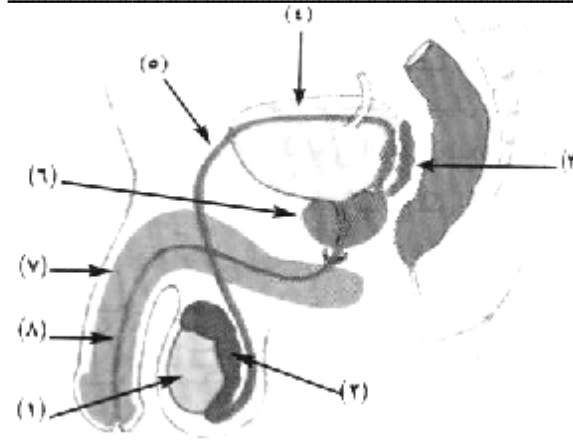
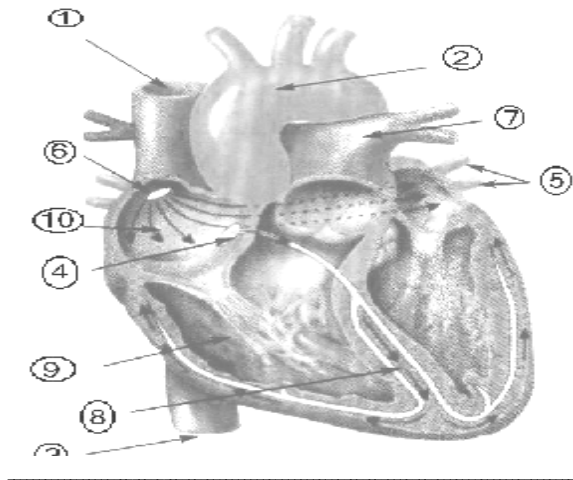

Abou Shahin 0102202654

بِسْمِ اللَّهِ الرَّحْمَنِ الرَّحِيمِ (وَاصْبِرْ وَمَا صَبْرُكَ إِلَّا بِاللَّهِ وَلَا تَحْزَنْ عَلَيْهِمْ وَلَا تَكُ فِي ضَيْقٍ مِّمَّا يَمْكُرُونَ) (الاحزاب: 127)

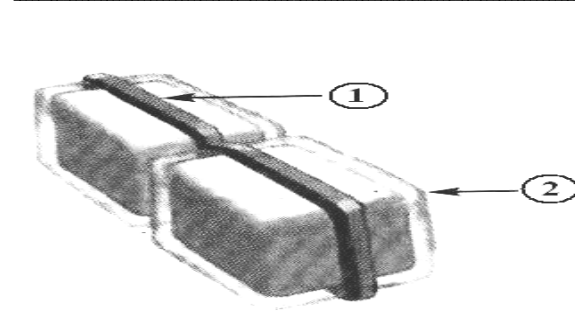
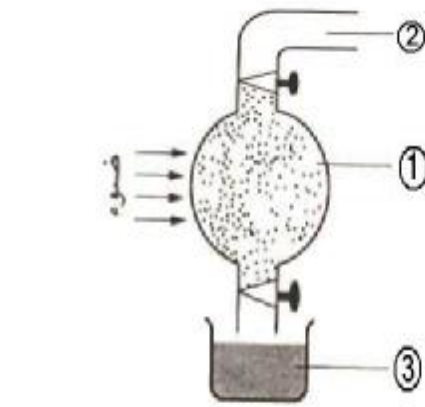
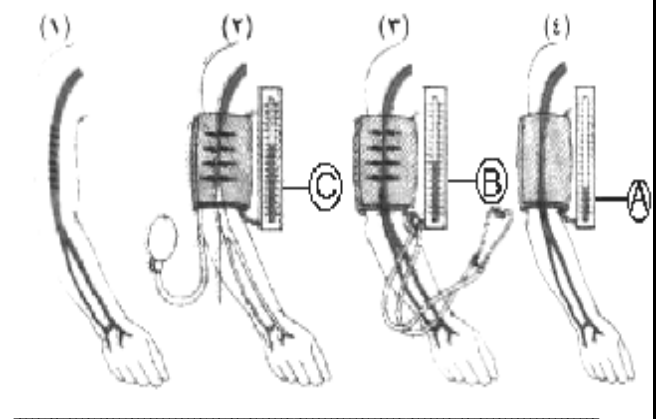
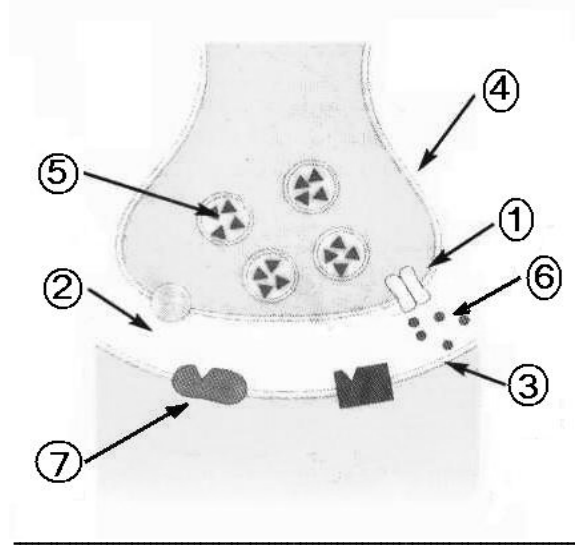
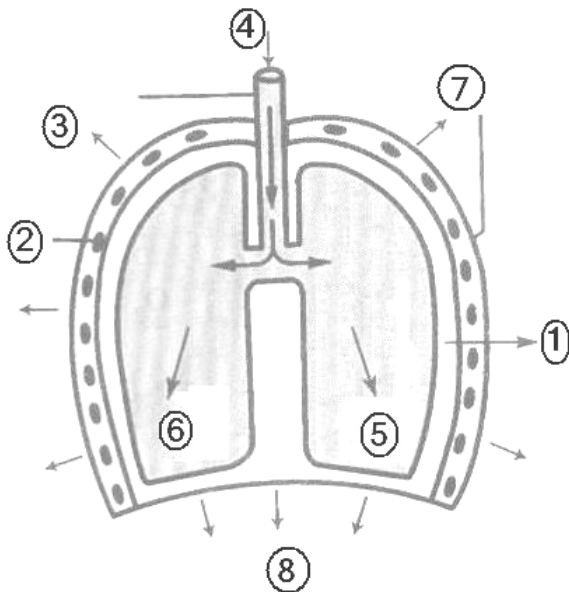
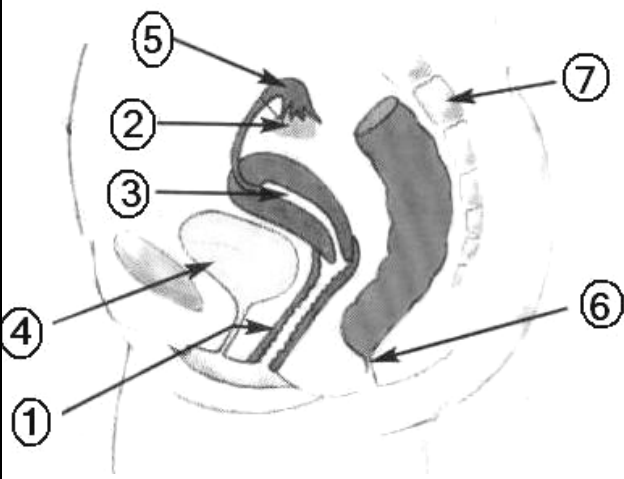
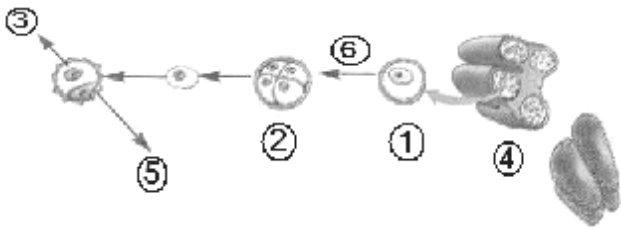
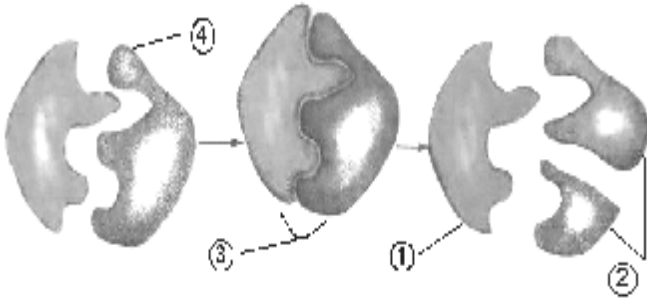

بِسْمِ اللَّهِ الرَّحْمَنِ الرَّحِيمِ (وَاصْبِرْ وَمَا صَبْرُكَ إِلَّا بِاللَّهِ وَلَا تَحْزَنْ عَلَيْهِمْ وَلَا تَكُ فِي ضَيْقٍ مِّمَّا يَمْكُرُونَ) (النحل: 127)

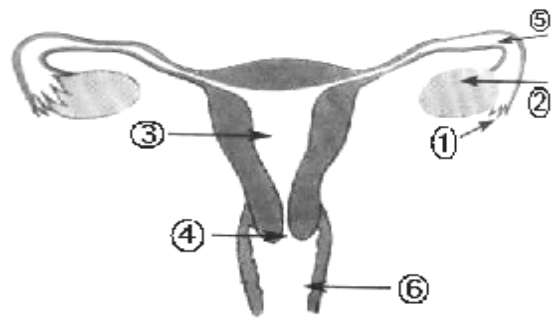
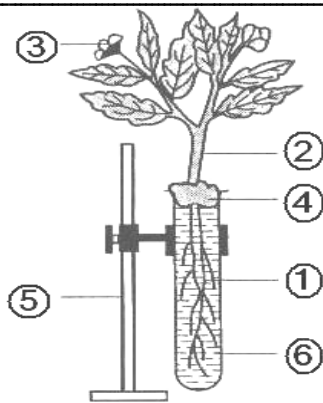
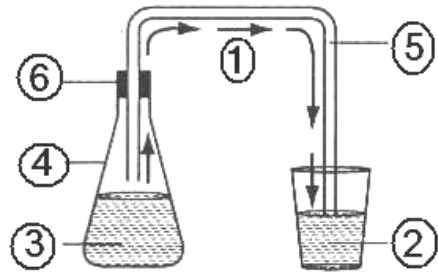
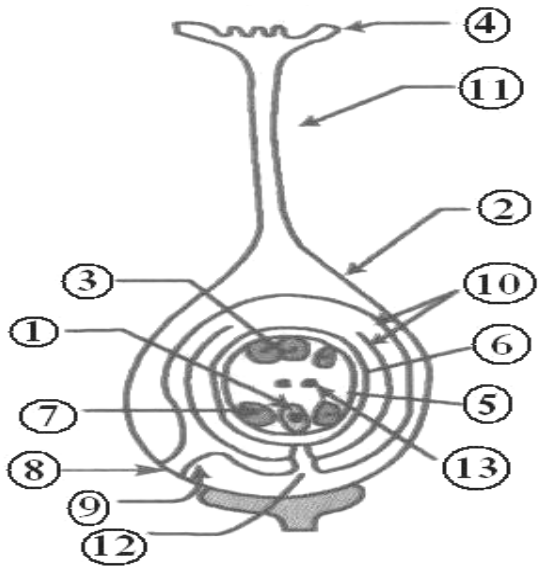
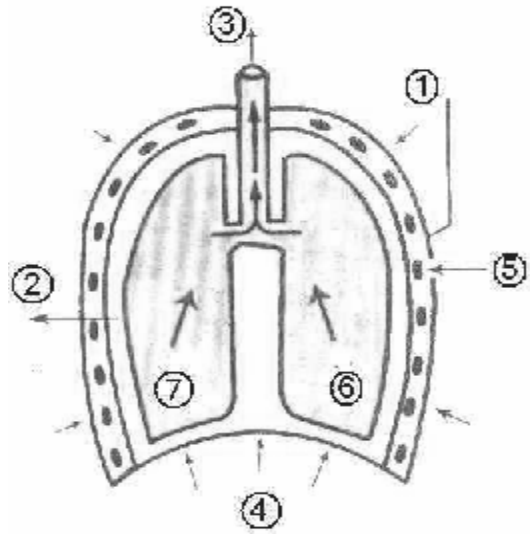
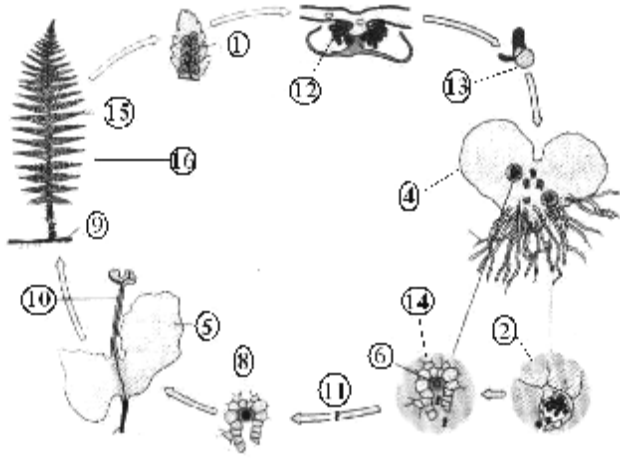
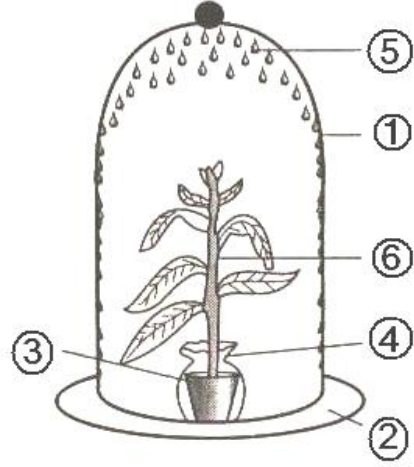
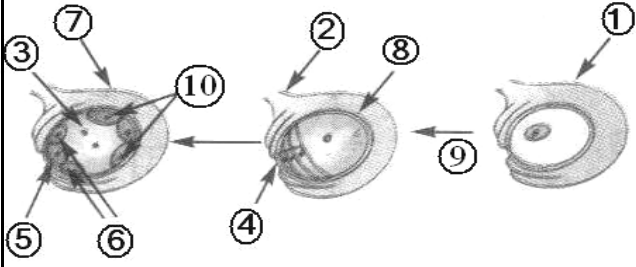

بِسْمِ اللَّهِ الرَّحْمَنِ الرَّحِيمِ (وَاصْبِرْ وَمَا صَبْرُكَ إِلَّا بِاللَّهِ وَلَا تَحْزَنْ عَلَيْهِمْ وَلَا تَكُ فِي ضَيْقٍ مِّمَّا يَمْكُرُونَ) (النحل: 127)

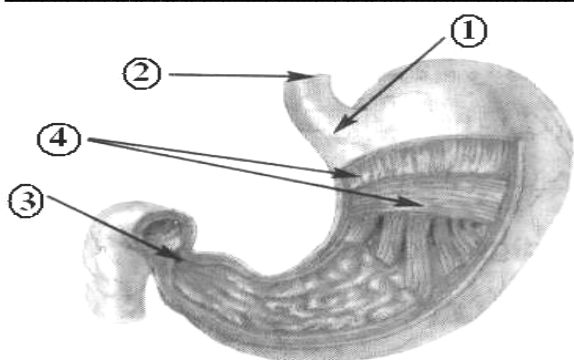
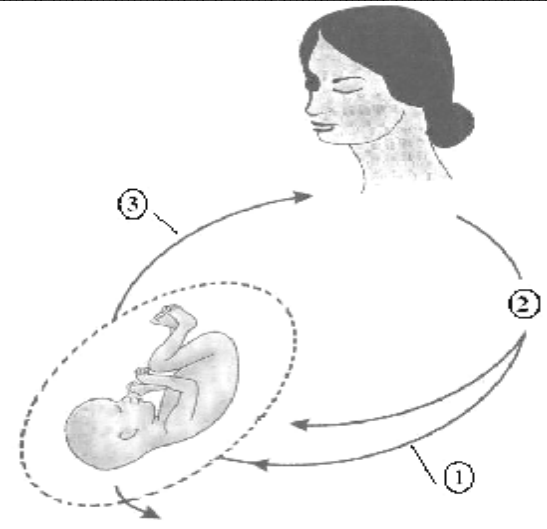
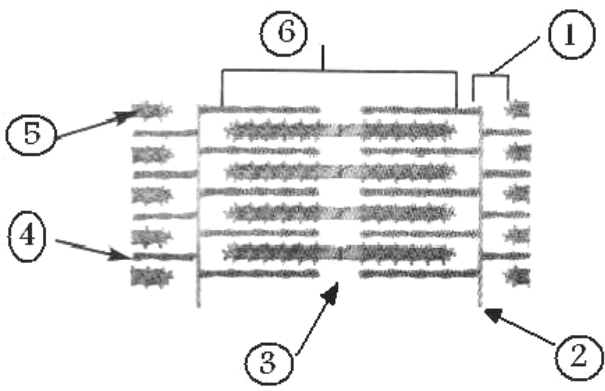
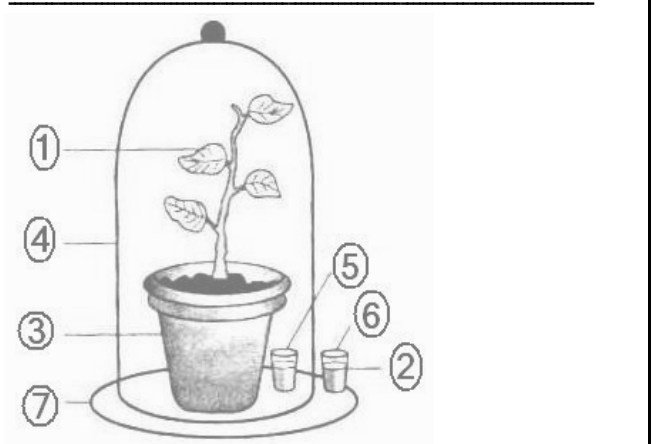
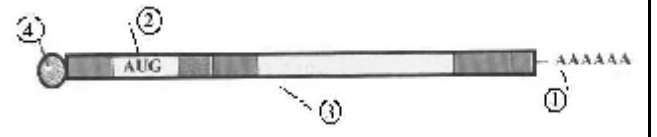
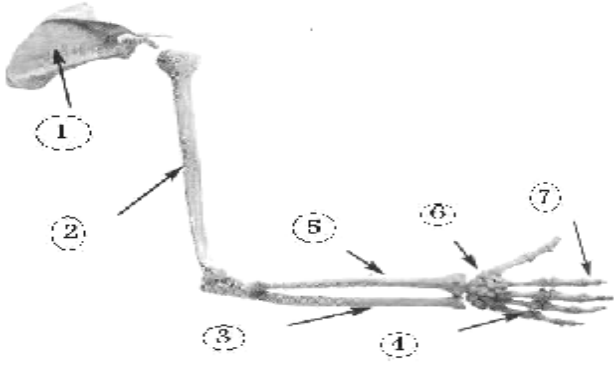
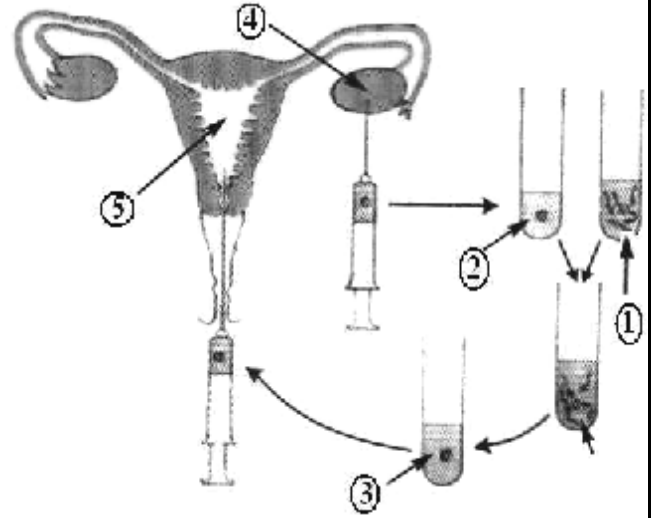
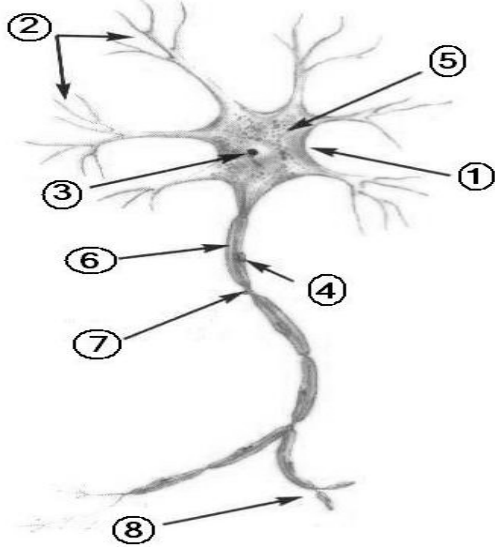

Abou Shahin 0102202654

بِسْمِ اللَّهِ الرَّحْمَنِ الرَّحِيمِ (وَاصْبِرْ وَمَا صَبْرُكَ إِلَّا بِاللَّهِ وَلَا تَحْزَنْ عَلَيْهِمْ وَلَا تَكُ فِي ضَيْقٍ مِمَّا يَمْكُرُونَ) (النحل: 127)

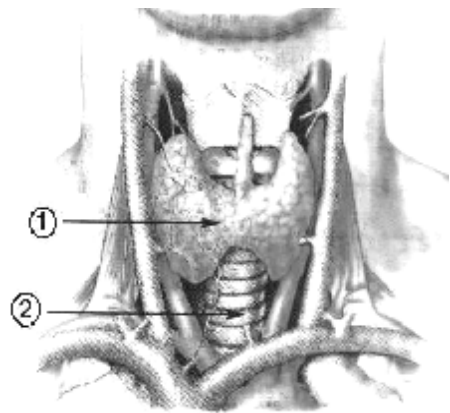
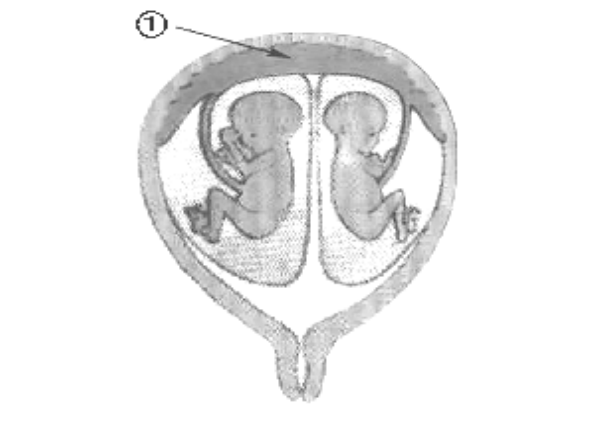
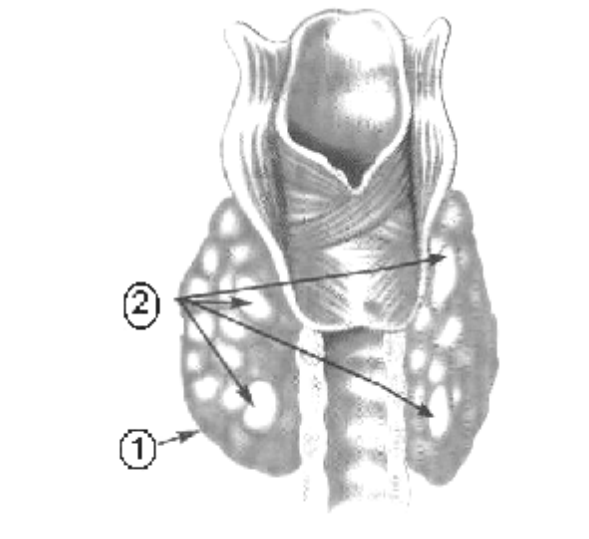
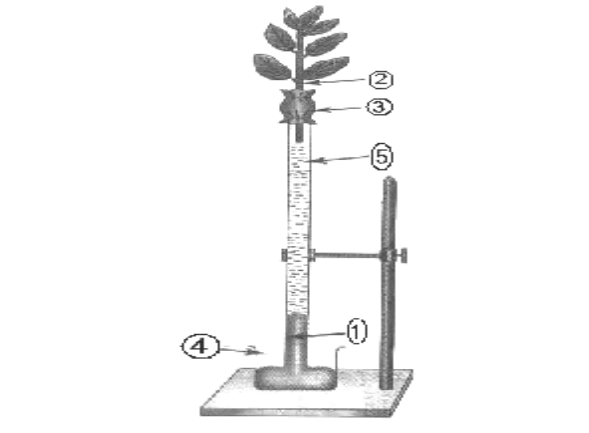
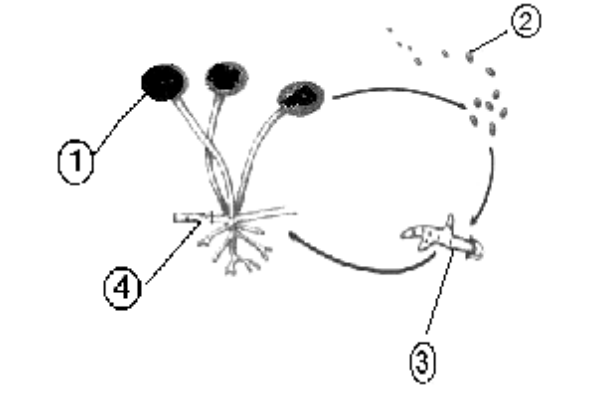
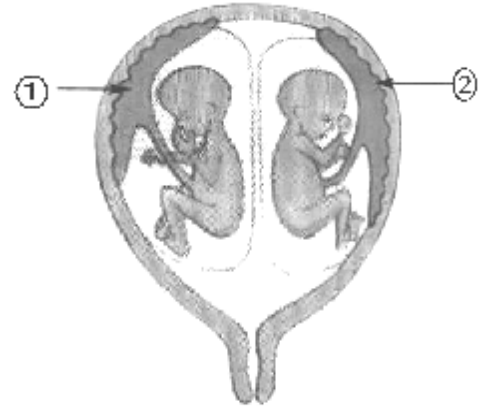
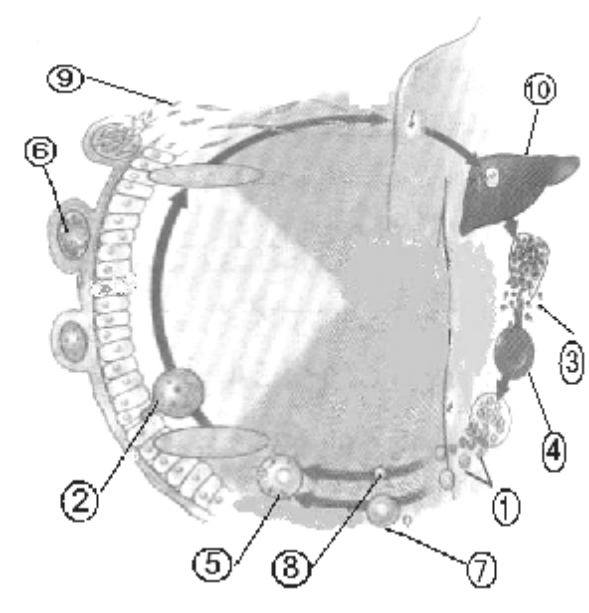

Abou Shahin 0102202654

بِسْمِ اللَّهِ الرَّحْمَنِ الرَّحِيمِ (وَاصْبِرْ وَمَا صَبْرُكَ إِلَّا بِاللَّهِ وَلَا تَحْزَنْ عَلَيْهِمْ وَلَا تَكُ فِي ضَيْقٍ مِّمَّا يَمْكُرُونَ) (النحل: 127)

